

Eventing Minderhout 22 & 23.03.2014

1

A. Eiken

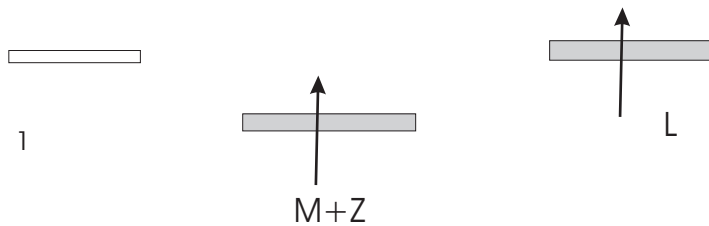

B. Trippel

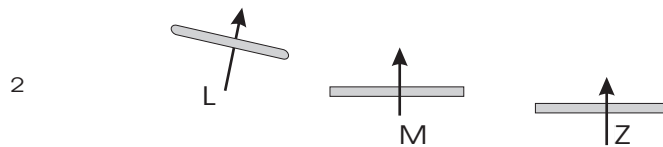

C2 Blauwbossen wal

3 A B

C1 KBC Bank

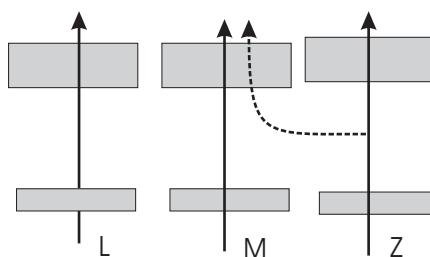

D. Desdalex Trakener

4

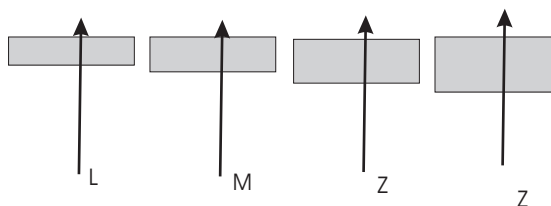

E 2 Rikkes Wal

E1 Heiweiput

5 A B

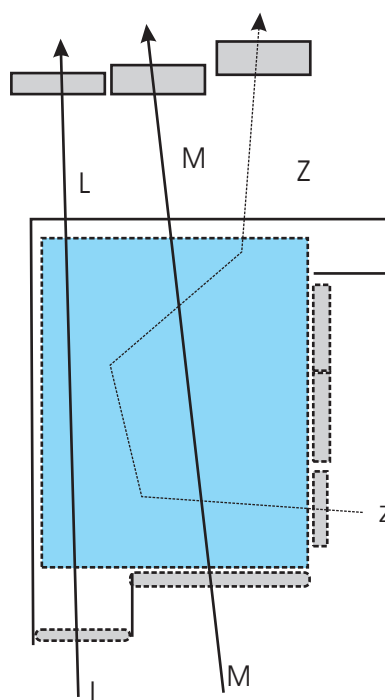

L 6

M 6 A B

Z 6 A B C

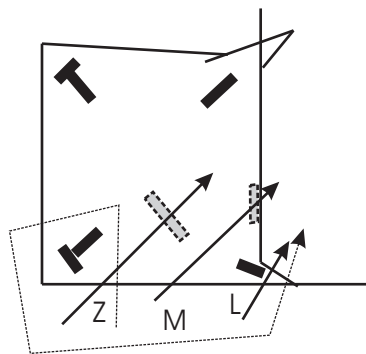

G 2. Palissade

7 A B

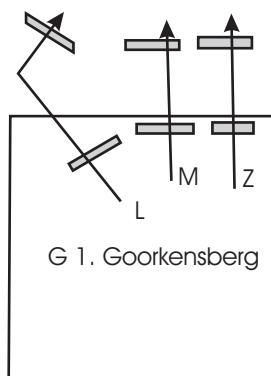

H . Vissersprong

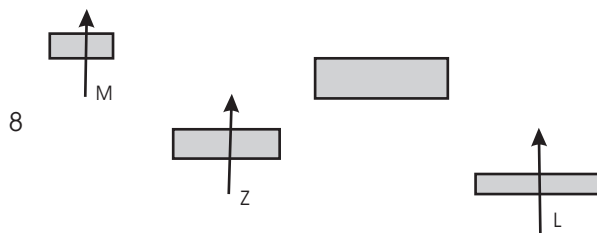

9 A B

I 2. Kleiput-in

I 1. Zwarte wal

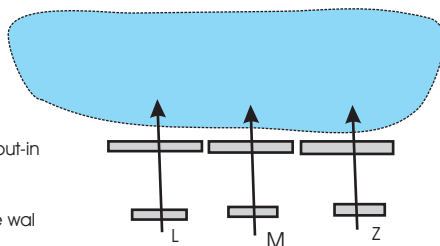

J Eiland

10

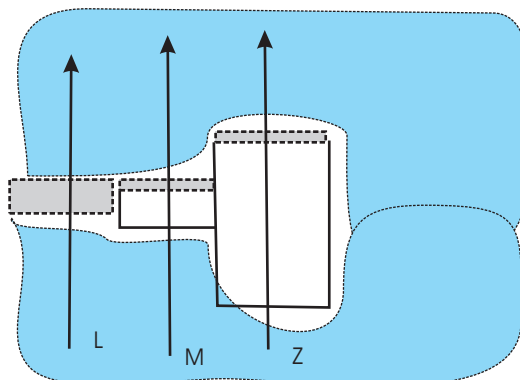

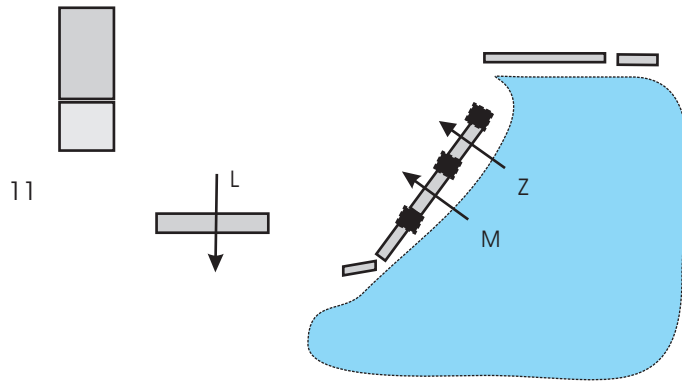

L 2 Kempische boerderij

L 12 A B C

M 12 A B C D

Z 12 A B C D E

L 1 Piano

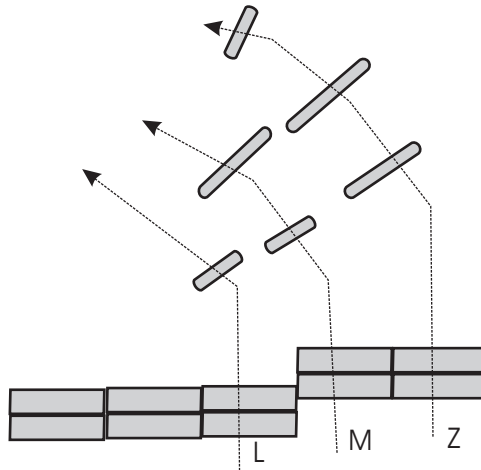

M 2 V Sprong

13 A B

M 1 Haag Sloot

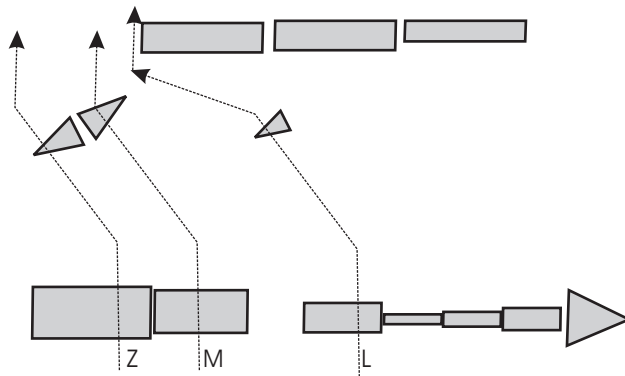

N Tafels

14

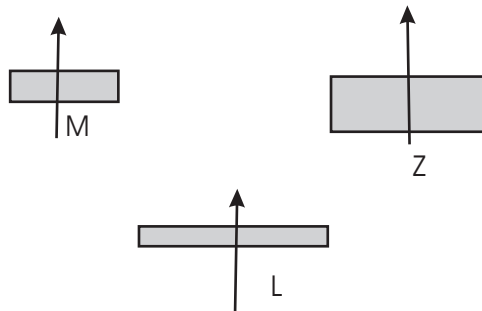

O. Jantjes Drinkenbak

15

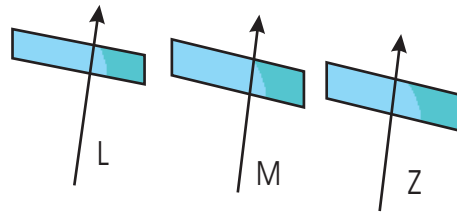

P. HAGEN

16 ABC

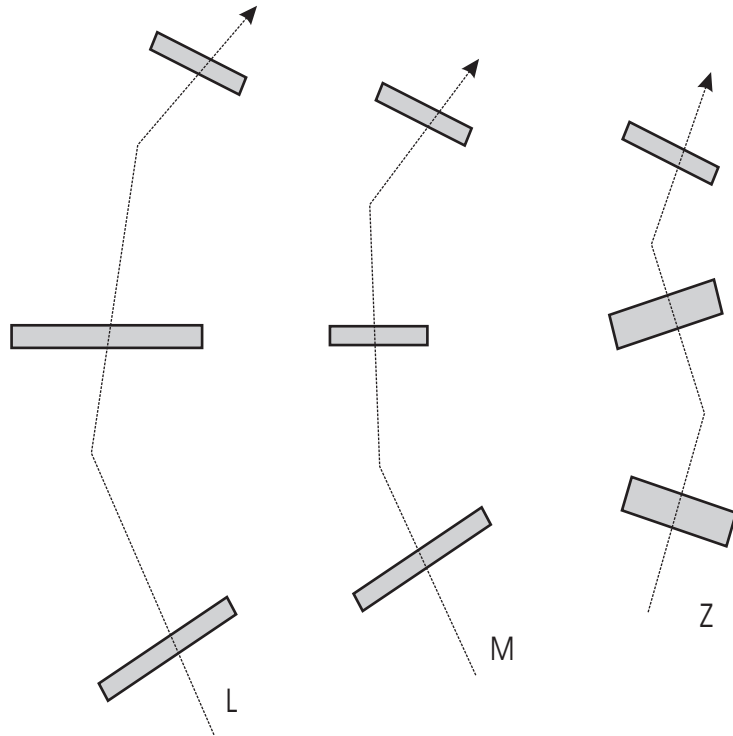

Q. Jagershut

17

