

## A. Eiken

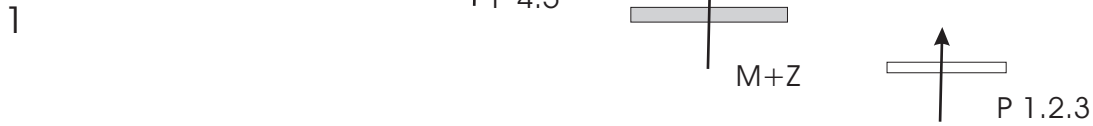

## B. Trippel



## 3 C KBC Bank

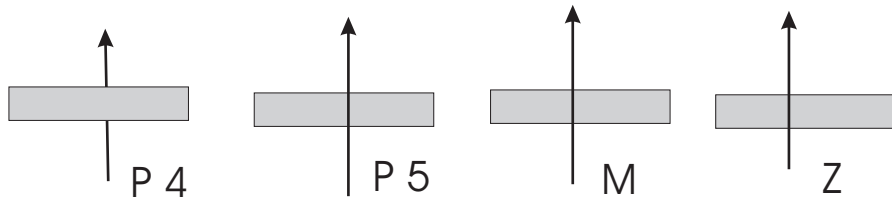

## D Desdalex Trakener

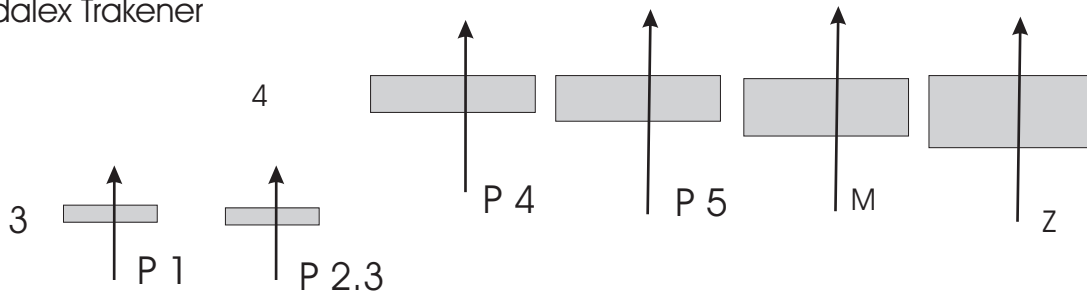

## E 2 Rikkes Wal

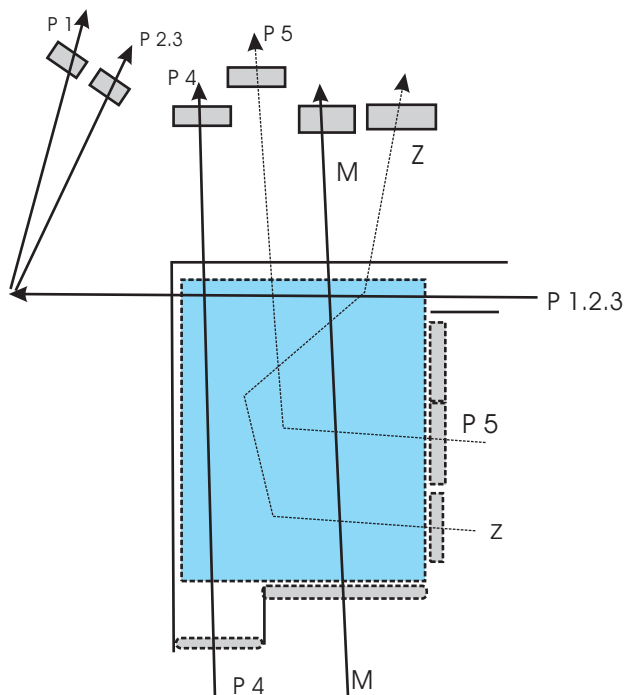

## E1 Heiweiput

P 1.2.3 4 en 5

P 4.5 M en Z 5 A B

P 1.2.3.4 6

P 5 M en Z 6 A B

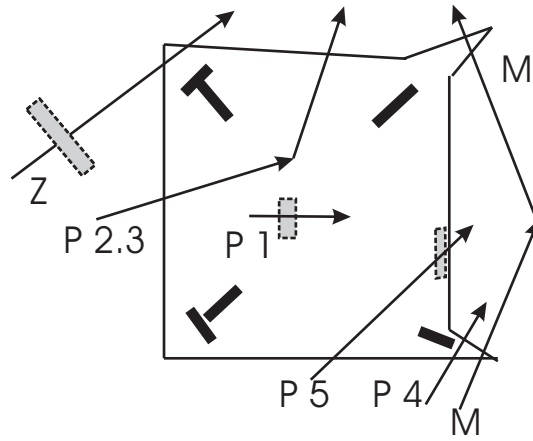

G 2. Palissade

P 5 M en Z 7 A B

P 1.2.3.4 7

G 1. Goorkensberg

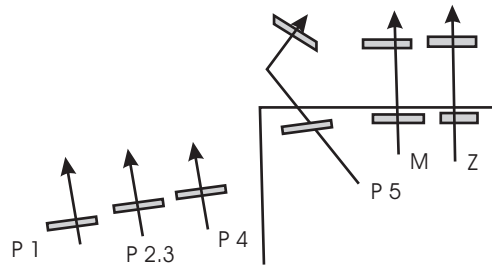

H. Vissersprong

8

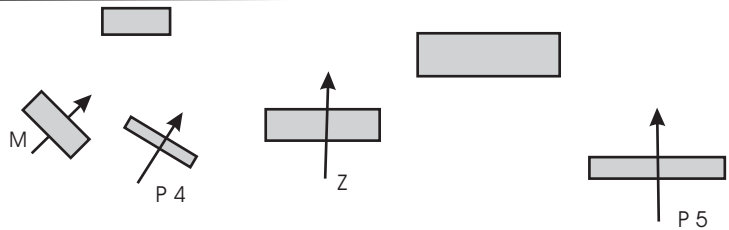

I. Kleiput-in-uit

Z 9 A B

P 1.2.3 8 A B

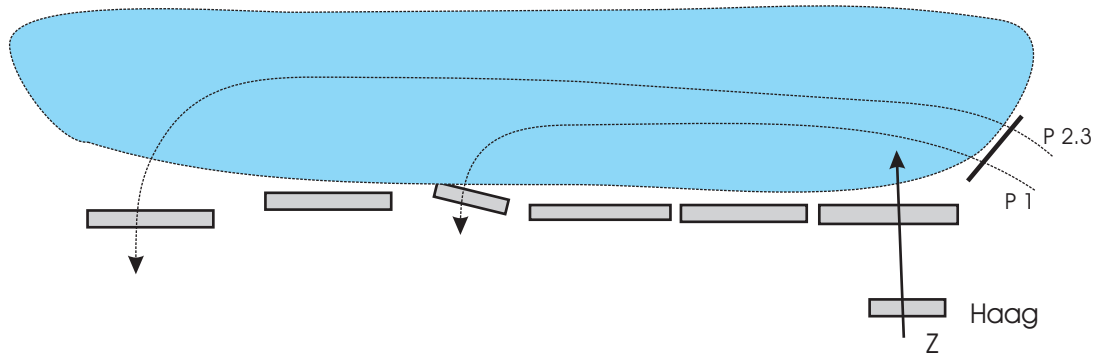

J Destafort

Z 10 A B

P 4.5 en M 9

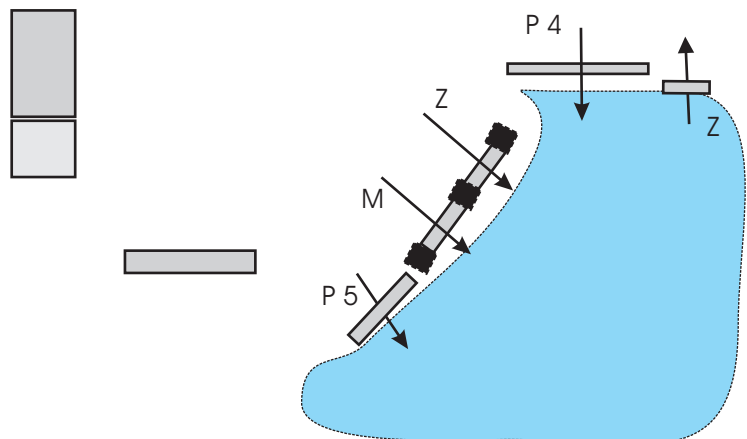

P 4.5 en M 10

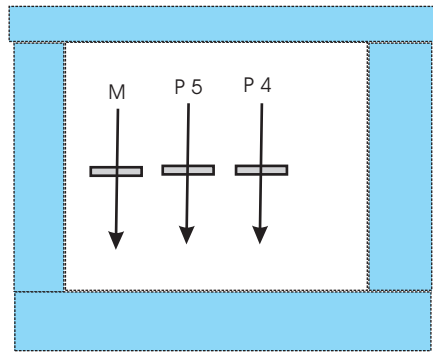

L 2. Kempische boerderij 12 A B

Alternatief voor P 5 en M en Z

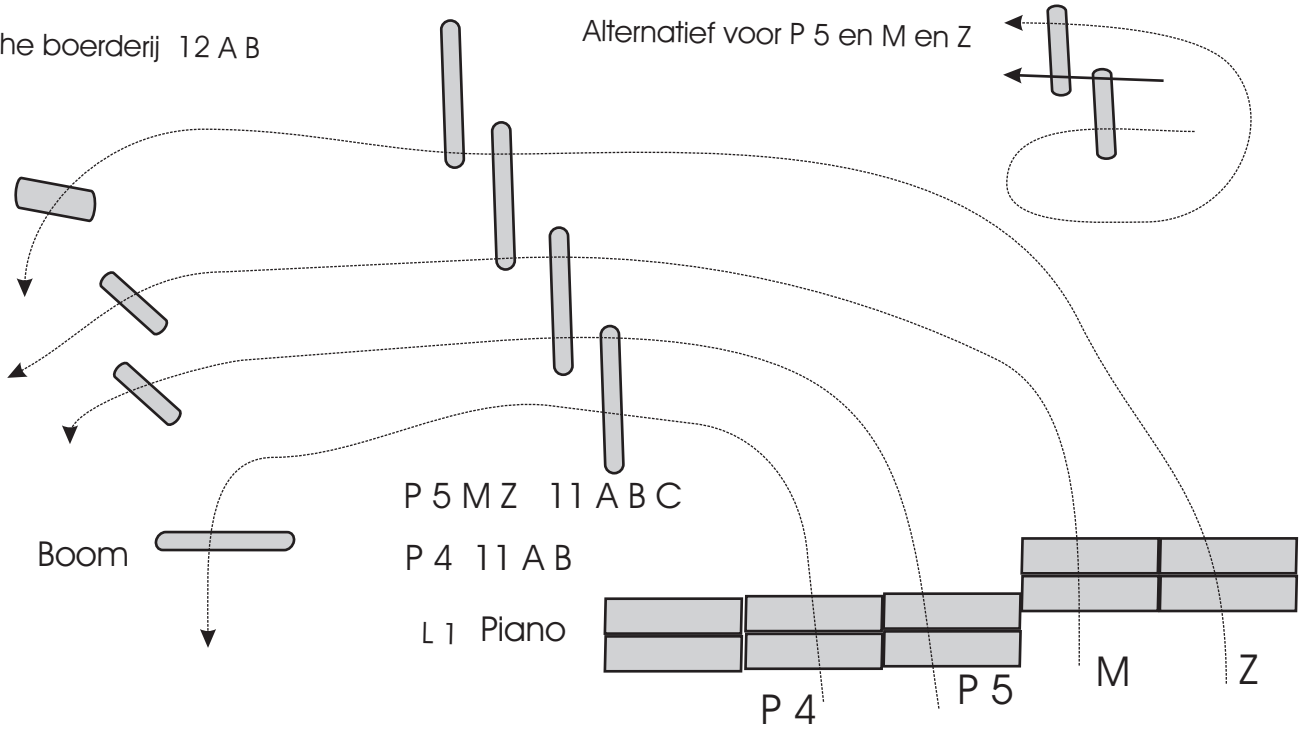

M 2 V Sprong voor P 5 en M Z

13 B

13 A

M 1 Haag Sloot voor P 5 en M Z

Alternatief P 1.2.3 10

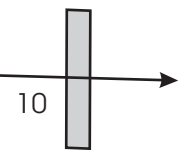

M 1 Palissade voor P 1.2.3 9

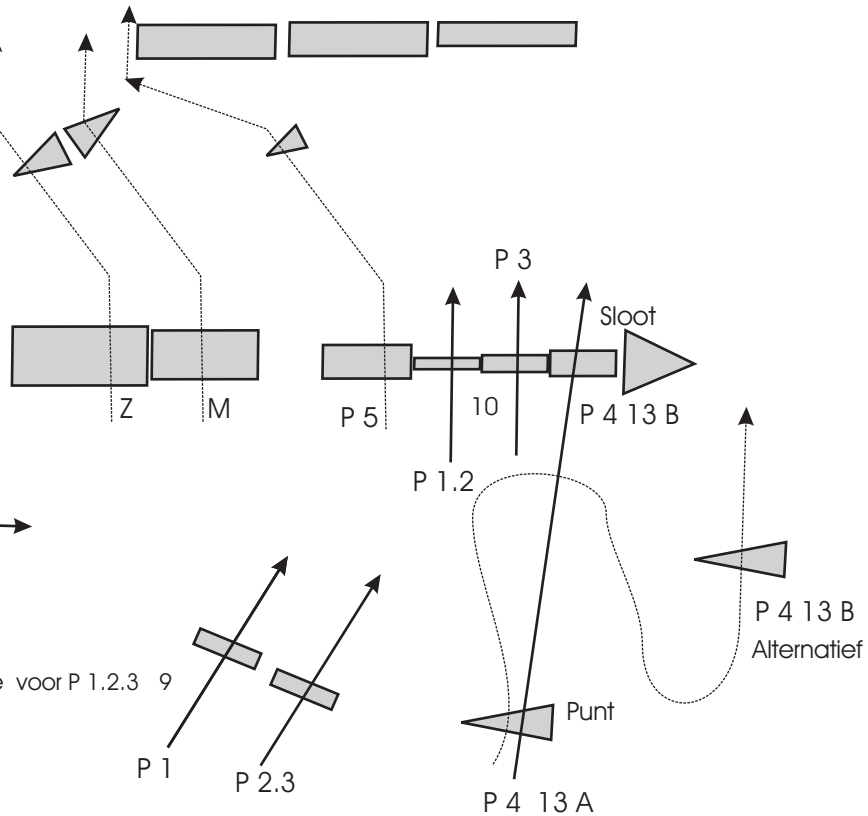
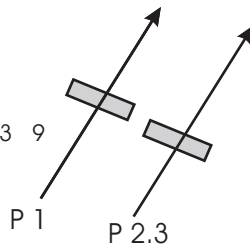

N Tafels

4

P 4.5 M Z 14

P 1.2.3 11

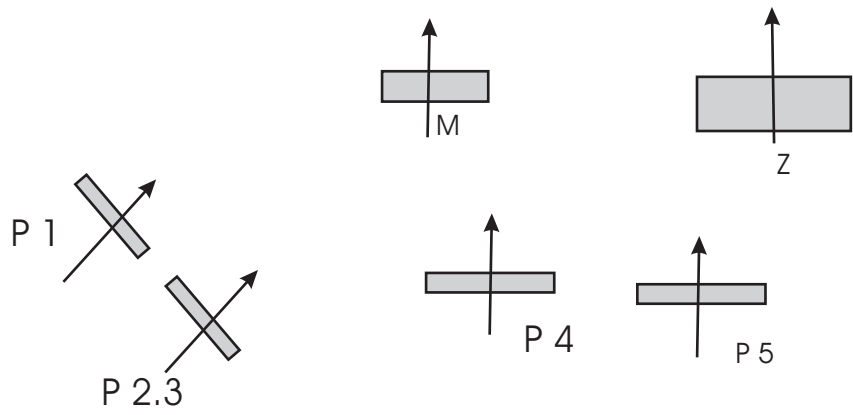

O. Jantjes Drinkenbak

P 4.5 M Z 15

P 1.2.3 12

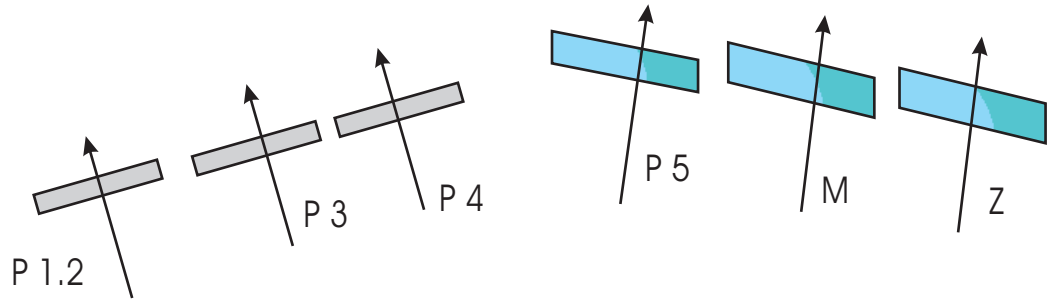

P. Hagen

P 4.5 M Z 16 AB

P 1.2.3 13 14

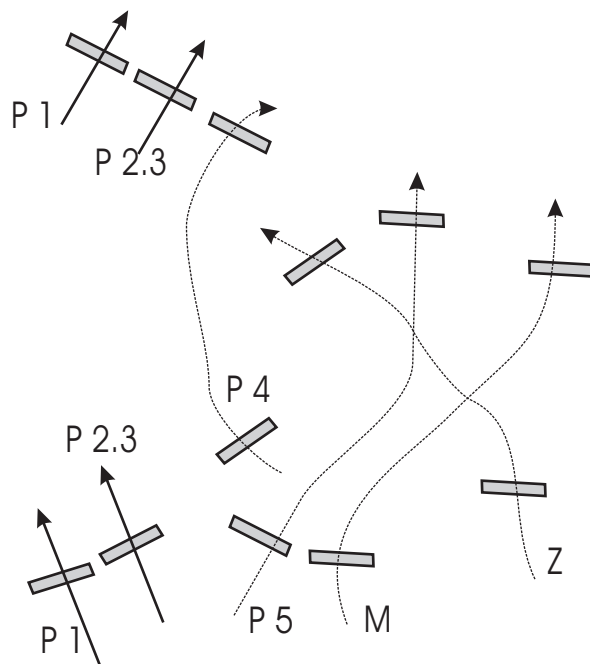

Q. Jagershut

P 4.5 M Z 17

P 1.2.3 15

